



NEMO Consultation on CACM Methodologies

Interim NEMO Committee

14 November 2016

Agenda

10:30 – 10:45 Introduction

10:45 – 12:30 Max-Min Price Proposal;
Back-up Methodology Proposal

12:30 – 13:30 Lunch

13:30 – 16:30 Algorithm Proposal incorporating Day-Ahead and Intraday
algorithm requirements;
Products Proposal

16:30 – 17:00 Wrap-up

Introduction

- CACM assigns responsibilities jointly to NEMOs: notably regarding the DA and ID MCO function
- On 3 March 2016 the Interim NEMO Cooperation Agreement (INCA) entered into effect, signed by all 19 designated NEMOs*. The INCA establishes:
 - An Interim NEMO Committee
 - Decision making based on Article 9(2) of CACM
 - A framework for all NEMOs to develop and propose the MCO plan and other Article 9(6) methodologies
- The interim governance arrangements established by the INCA will be replaced by enduring arrangements as proposed in the MCO plan
 - In 2017, subject to MCO Plan approval, NEMO Committee also assumes overall responsibility for DA and ID MCO functions

* APX Commodities Ltd., APX Power B.V., Belpex SA, BSP Regional Energy Exchange LLC, Croatian Power Exchange Ltd., EirGrid plc, EPEX SPOT SE, EXAA Abwicklungsstelle für Energieprodukte AG, Gestore dei Mercati Energetici S.p.A.(GME), HUPX Hungarian Power Exchange Company Limited by Shares, Independent Bulgarian Energy Exchange EAD, Operator of Electricity Market S.A., Nord Pool AS, OKTE a.s., OMI - Polo Español S.A. (OMIE), Operatorul Pieței de Energie Electrică și de Gaze Naturale “OPCOM” SA, OTE A.S., SONI Limited and Towarowa Giełda Energii S.A.

Proposed NEMO organisation

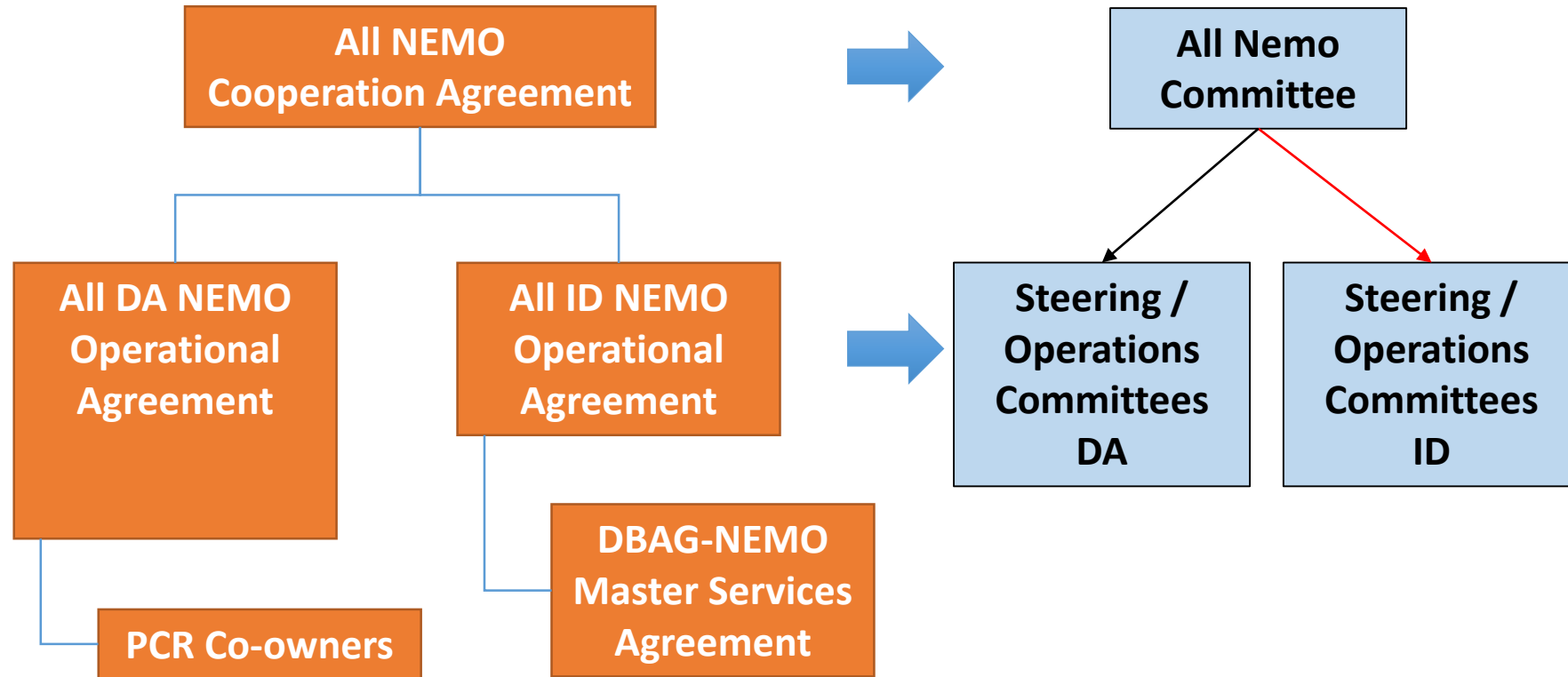

The MCO Plan explains how NEMOs will manage the transition to the DA and ID MCO functions for SDAC and SIDC

NEMO Deliverables

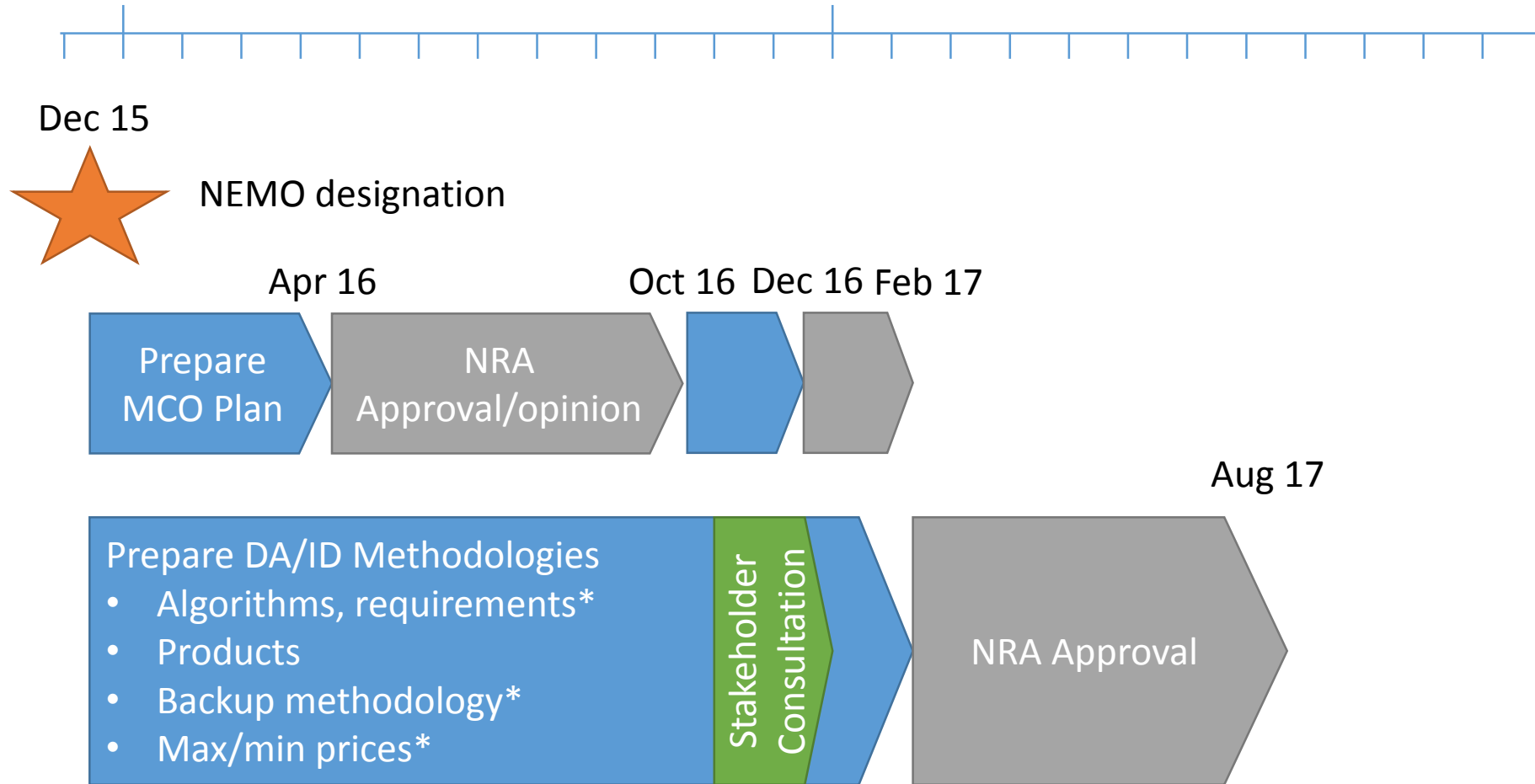

* In cooperation with TSOs

Agenda



10:30 – 10:45 Introduction

10:45 – 12:30 **Max-Min Price Proposal;**
Back-up Methodology Proposal

12:30 – 13:30 Lunch

13:30 – 16:30 Algorithm Proposal incorporating Day-Ahead and Intraday
algorithm requirements;
Products Proposal

16:30 – 17:00 Wrap-up

Key examples of matters that have guided the development of the “Min-Max Limit Proposal” that is now subject to public consultation

1. Recognition of the different meaning and usefulness of (Technical) Price Limits for SDAC/SIDC given by the fact that SDAC is based on an Implicit Auction and SIDC on Continuous Implicit Trading, and with ID being closer to real time
2. The relationship between the for technical or other reasons set Price Limits in relation to SDAC/SIDC markets versus in Balancing Arrangements/Markets, and to what extent Scarcity is revealed in Planning Stage or only Real Time
3. The importance of establishing a clear criterion based change management process for any initially set or prevailing Price Limits based on technical, economic risk or other factors in SDAC/SIDC and Balancing
4. The fact that NEMOs as a principle do not set limits to restrict trading prices but mainly for technical/administrative reasons, and therefore limits can be adjusted to ensure that the markets can function also in case of risks for scarcity or over-supply
5. The importance of having harmonized Price Limits for all Bidding Zones in SDAC and SIDC respectively, but still provide allowance for local/regional Derogations if needed and justified based on relevant criteria and CACM Objectives
6. That the harmonised limits should undergo a regular re-assessment by All NEMOs in collaboration with All TSOs, and that it would be done as a minimum every other year, and include an assessment against the CACM Objectives.

Harmonised Minimum-Maximum Clearing Price Limits Proposal

- Articles 1.1 to 1.6 Background for the Proposal on the basis of requirements in CACM GL
- Articles 1.7 and 1.8 (1-9) Assessment of the Proposal's impact on objectives of CACM GL
 - **Generally the brief assessment concludes that the Proposal fulfills the objectives (relevant for this Proposal)**
- Article 2 – a few definitions are provided
- Articles 3 and 4 – the harmonized limits for SDAC and SIDC are presented
 - **For SDAC the proposal is to make the current limits in DA MRC (and 4MMC), namely -500 to +3000 EUR/MWh apply everywhere**
 - **For SIDC the proposal currently provides an option to either have limits like in SDAC or -9999 to +9999 EUR/MWh due to that there in reality in essence only is a pure technical reason for limits in a continuous implicit market.**
 - This is detailed in a Consultation Question, thus we encourage feed-back on the matter of equal or not limits for SDAC and SIDC and which of the two options in SIDC is preferred and why.

Harmonised Minimum-Maximum Clearing Price Limits Proposal

- Article 5 – timeline of implementation Requirement for cross zonal capacities for allocation
 - **NEMOs shall adopt the Harmonised Clearing Price Limits with the implementation of SIDC and SDAC.**
 - **A NEMO shall apply, in its role as NEMO, the Harmonised Minimum and Maximum Clearing Price limits from the point at which the NEMO joins the operational SDAC or SIDC solution respectively.**
- Article 6 - Criteria and Process for establishing and amending Harmonised Clearing Price Limits
 - **Provides background to needs processes and objectives to fulfill in case Derogations on local/regional level were to be implemented – and also two types of Derogations:**
 - Derogations that require NEMOs, TSOs to agree and NRAs to approve (Art. 6.1), and
 - Temporary Derogations that would be decided by the All NEMO Committee without NRA approval, given that relevant objectives etc. are fulfilled (Art 6.3)
 - In all cases it is clarified that All NEMOs within given Bidding Zones/MS/Regions would apply identical limits
 - **It is also clarified that any Derogation may trigger an assessment also of the Harmonised Clearing Price Limits (Art. 6.4)**
 - **As a minimum an assessment every other year will be made of the Harmonised Clearing Price Limits (Art 6.5)**

Consultation Questions for the Harmonized Max-Min clearing price Limit Proposal

1. Do you find that the proposal addresses all the relevant objectives and issues that it should? If not kindly list key issues not covered.....

2. In the proposal being consulted upon two different levels are indicated as possible price limits to apply in the Single Intra Day Coupling (SIDC), one like proposed for Single Day Ahead Coupling (SDAC) and one with a wider range. The reason being that SIDC, contrary to SDAC (Implicit Auction), is based on continuous trading and matching of individual orders based on a continually, for each Bidding Zone, visible best bid/ask spread and accordingly there is no clear relevance for limits other than on technical grounds. On that basis we have these specific questions linked to the price limits to be applied:
 - A. Do you have any opinion about if the clearing price limits set for Single Day Ahead Coupling (SDAC) and Single Intra Day Coupling (SIDC) should be identical or different?
 - B. If you argue for different levels can you kindly provide reasoning for why that should be the case:
 - C. Do you have any opinions about the limits proposed for SDAC? If you disagree with the proposed limits what would you deem as more appropriate clearing limits and can you elaborate on why?
 - D. Do you have any opinion about either of the options (A: +3000/-500; B:+9999/-9999) proposed as clearing limits for SIDC? If you disagree with both sets of proposed limits what would you deem as more appropriate clearing limits and can you elaborate on why?

3. Do you have any suggestions on how to over time tackle the required need to consider the clearing limits in relation to Value of Lost Load (VOLL)?
 - A. Further, do you have a suggestion on how to in relation to clearing price limits tackle the fact that there is no uniform VOLL across the EU?

4. While the Proposal clearly says that harmonised clearing price limits shall apply for SDAC and SIDC respectively it also allows for derogations based on two options, namely (a) an agreement between relevant NEMOs and TSOs and approval by NRAs (Article 6.1), or (b) temporary derogations decided upon by the All NEMO Committee (Article 6.3), and for both options it may be valid in single Member States, Bidding Zones and regions or the whole SIDC or SDAC geographic scope if due consideration is made of the impact on the objectives of the regulation.
 - A. What is your view on the derogation option in Article 6.1?
 - B. What is your view on the temporary derogation option in Article 6.3?
 - C. What is your view in general about possible existence of derogations, and do you find that, when such decisions are made, the measures proposed to ensure consideration of overall objectives are sufficient?

5. Do you have other specific feed-back on this harmonized clearing Min-Max limit Proposal?

Agenda



10:30 – 10:45 Introduction

10:45 – 12:30 Max-Min Price Proposal;
Back-up Methodology Proposal

12:30 – 13:30 Lunch

13:30 – 16:30 Algorithm Proposal incorporating Day-Ahead and Intraday
algorithm requirements;
Products Proposal

16:30 – 17:00 Wrap-up

Introduction

- According to Article 36(3) *“By 18 months after the entry into force of this Regulation, all NEMOs shall in cooperation with TSOs develop a proposal for a back-up methodology to comply with the obligations set out in articles 39 and 52 respectively”*.
- According to Article 7(1)(h), NEMOs are responsible for establishing jointly with relevant TSOs back-up procedures for national or regional market operation in accordance with Article 36(3) if no results are available from the MCO functions in accordance with Article 39(2), taking into account of fallback procedures provided for in Article 44.
- According to Article 36 *“The proposal for a methodology shall be subject to consultation in accordance with Article 12”*.
- The NEMOs proposal for a Backup Methodology will be prepared in cooperation with TSOs, taking into account the comments from the consultation, and will be submitted to the Regulatory Authorities for approval no later than 18 months after the entry into force of the CACM Regulation, i.e.14 February 2017.

Introduction (2)

Differences between Backup and Fallback provisions

- Backup refers to mechanisms that need to be established to ensure that when problems or events appear applying the normal procedures to get results some backup procedures are established and followed:
 - The necessary inputs and results of the DA coupling (Article 39 **Inputs and results of the price coupling algorithm**): TSO inputs (network capacities and constraints); NEMO inputs (orders); algorithm results (prices, net positions); validation
 - The necessary inputs and results of the ID coupling (*Article 52 Results of the continuous trading matching algorithm*)
- NEMOs interpretation is that:
 - **Backup** mechanisms, under NEMOs' responsibility, are procedures and steps to be taken when problems or issues appear in the daily operation of the DA or ID coupling, but still the final results are achievable (Coupled prices and cross border flows)
 - **Fallback** procedures, under TSOs' responsibility, are procedures to be followed, in case coupled prices or cross-border flows cannot be obtained for either DA or ID coupled markets.

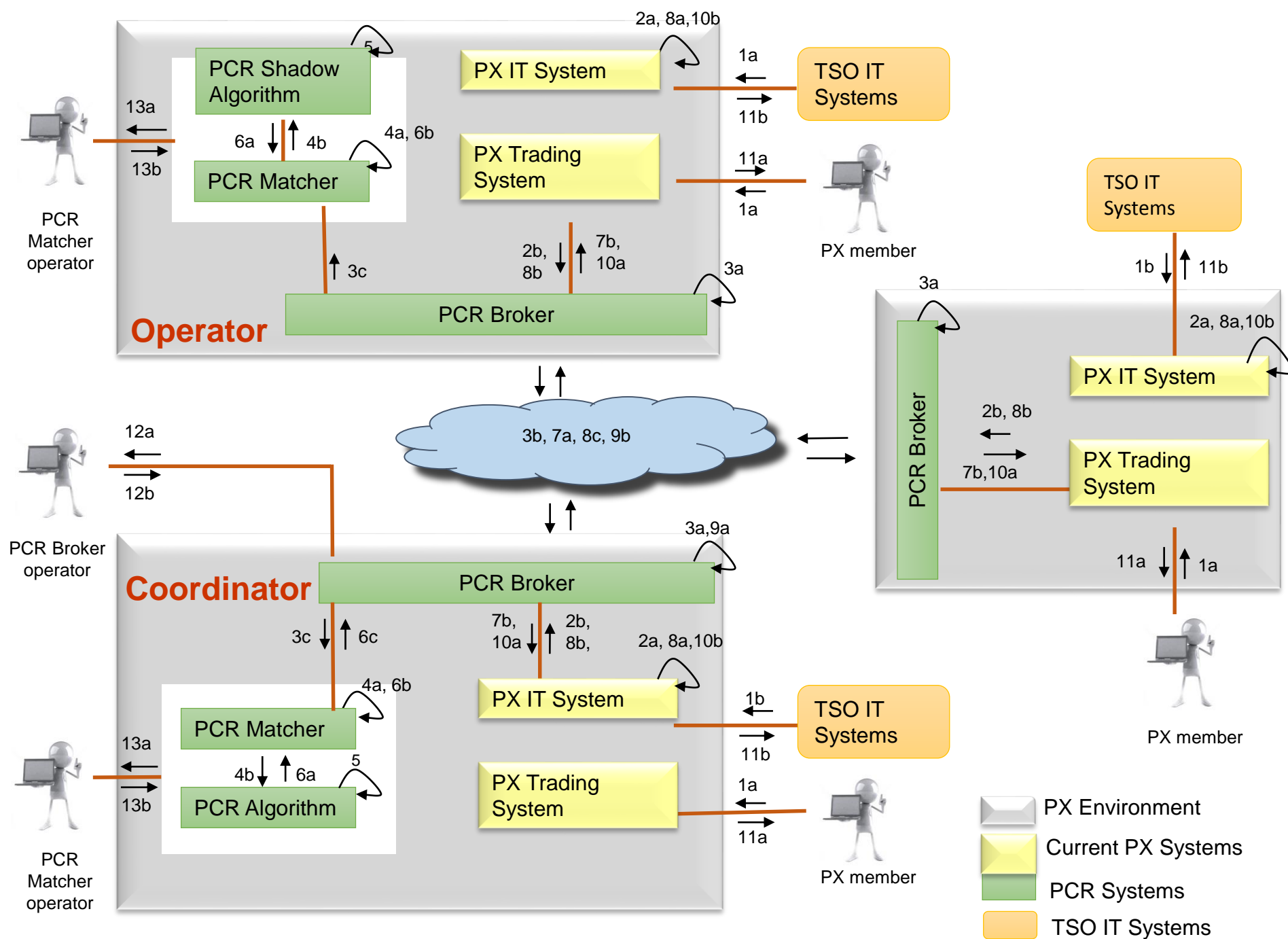

SDAC back-up procedures and steps (1)

- Requirement for back-up common communication system
 - **Objective:** solve technical problems in the communication system common to all Operators.
 - **Requirement:** at least one alternative connection among all Operators.
 - **Followed by:** all Operators.
- Requirement for back-up datacenter
 - **Objective:** solve technical problems in the main datacenter used by each Operator.
 - **Requirement:** a switch to the secondary datacenter, if available.
 - **Followed by:** all Operators who have a secondary datacenter.
- Requirement for Backup Coordinator
 - **Objective:** solve problems when the Coordinator is affected.
 - **Requirement:** in case of inability of the Coordinator the Backup Coordinator will take the Coordinator role.
 - **Followed by:** all Operators.
- Requirement for cross zonal capacities for allocation
 - **Objective:** solve problems receiving the cross zonal capacities for allocation.
 - **Requirement:** every problem will be analyzed and depending on the nature will be fixed.
 - **Followed by:** all Operators.
- Requirement for aggregated anonymized order books
 - **Objective:** solve problems regarding order books reception.
 - **Requirement:** every problem will be analyzed and depending on the nature will be fixed.
 - **Followed by:** all Operators.

SDAC back-up procedures and steps (2)

- Requirement for algorithm results
 - **Objective:** solve problems regarding the SDAC results.
 - **Requirement:** every problem will be analyzed and depending on the nature will be fixed.
 - **Followed by:** all Operators and, if needed, the DA MCO Functions service provider.
- Requirement for Operators results confirmation
 - **Objective:** solve problems regarding Operators results confirmation of the Price Coupling Algorithm results.
 - **Requirement:** confirmation/rejection assures the compliance/non-compliance of the calculation outputs.
 - **Followed by:** all Operators.
- Requirement for TSOs results confirmation
 - **Objective:** solve problems regarding TSOs results confirmation of the Price Coupling Algorithm results.
 - **Requirement:** confirmation/rejection assures the compliance/non-compliance of the calculation outputs.
 - **Followed by:** all Operators.
- Requirement for timings
 - **Latest time to start Back-up Methodology in accordance with the CACM.**
- Requirements for technical support
 - **Objective:** solve problems regarding all approved common provided services.
 - **Requirement:** involved Operator will contact the relevant service provider.
 - **Followed by:** all Operators.

XBID high-level architecture

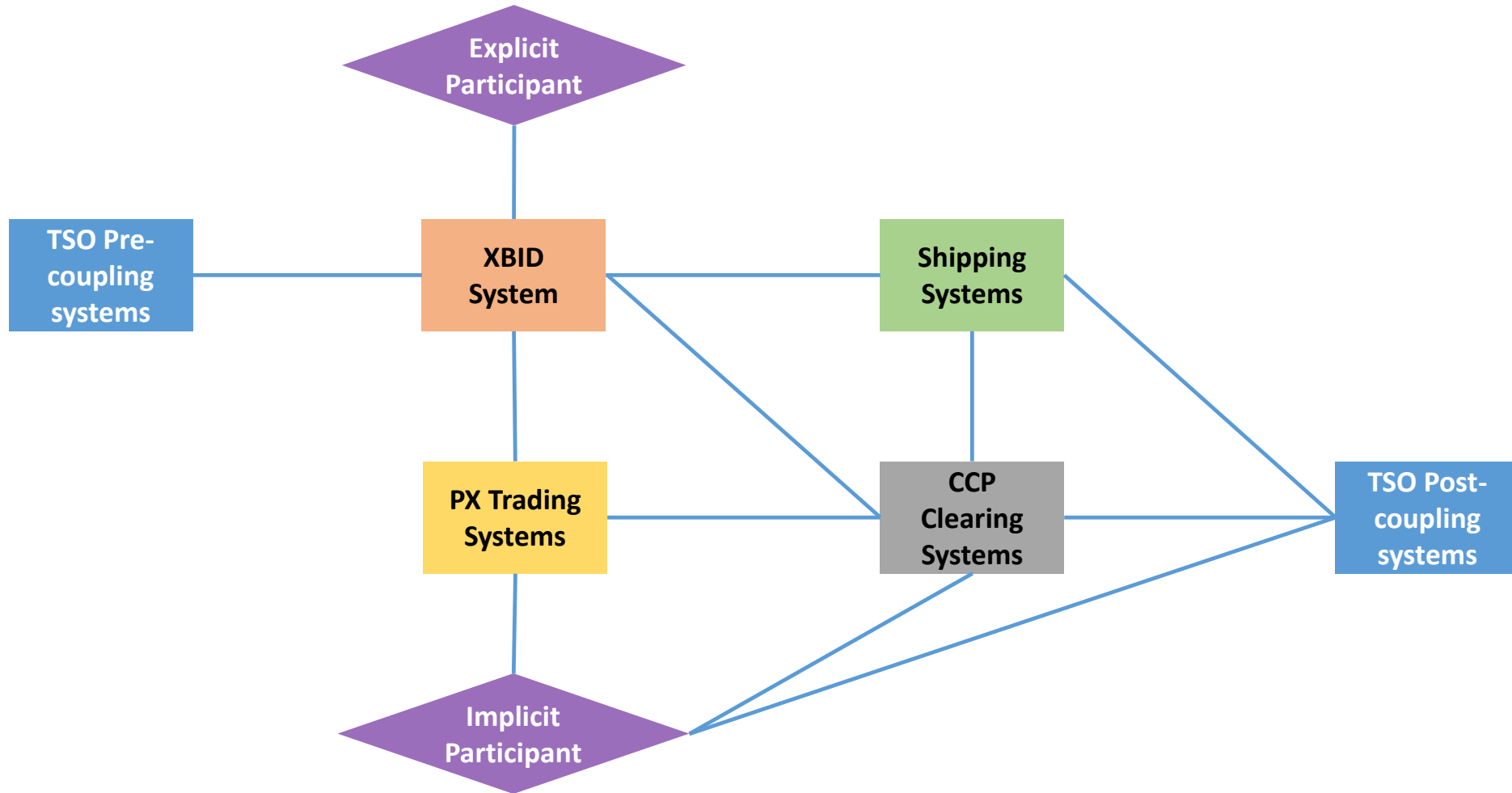

SIDC back-up procedures 1

- Requirement for back-up communications
 - Objective: solve technical problems in the communication line to the central XBID system.
 - Requirement: at least one alternative connection among all Operators (redundancy).
 - Followed by: all parties.
- Requirement for back-up transaction processes and files exchange
 - Objective: solve technical problems in the message and file exchange with the central XBID system .
 - Requirement: ad hoc.
 - Followed by: all parties.
- Requirement for capacity submission
 - Objective: solve network capacity submission problems.
 - Requirement: ad hoc.
 - Followed by: all TSOs.
- Requirement for order submission
 - Objective: solve order submission problems.
 - Requirement: ad hoc.
 - Followed by: all NEMOs.

SIDC back-up procedures 2

- Requirement for Explicit Participants
 - Objective: solve technical problems in the communication between explicit participants and the XBID system.
 - Requirement: ad hoc.
 - Followed by: all TSOs (with explicit access).
- Requirement for results delivery
 - Objective: solve problems and potential imbalances due to data inconsistency of the output information between different modules of the ID system, such as trades, capacity allocation, shipping and clearing information.
 - Requirement: ad hoc.
 - Followed by: all parties.
- Requirement for back-up operational processes
 - Objective: solve problems resulting from operational processes.
 - Requirement: ad hoc.
 - Followed by: all parties.
- Requirement for operational roles
 - Objective: solve problems resulting from the inability of parties to perform the operational role(s) assigned to them.
 - Requirement: apply back-up procedures.
 - Followed by: all parties.

SIDC back-up procedures 3

- Requirement for Closing & Restarting Areas
 - Objective: mitigate and solve situations and problems in the ID continuous market when an issue occurs.
 - Requirement: ad hoc.
 - Followed by: all parties.
- Requirement for trading algorithm
 - Objective: solve the case that the ID algorithm is down.
 - Requirement: ad hoc.
 - Followed by: all NEMOs.
- Requirement for capacity allocation
 - Objective: solve the case that the capacity allocation functions are down or malfunctioning.
 - Requirement: ad hoc.
 - Followed by: all parties.
- Requirement for shipping and clearing information
 - Objective: solve the case that the ID shipping and clearing information module is down or malfunctioning.
 - Requirement: ad hoc.
 - Followed by: all parties.

Agenda



10:30 – 10:45 Introduction

10:45 – 12:30 Max-Min Price Proposal;
Back-up Methodology Proposal

12:30 – 13:30 Lunch

13:30 – 16:30 **Algorithm Proposal incorporating Day-Ahead and Intraday
algorithm requirements;**
Products Proposal

16:30 – 17:00 Wrap-up

Algorithm Proposal – Context (Article 37)

- All TSOs and all NEMOs shall share proposals for a common set of requirements to enable the development of the price coupling algorithm and of the continuous trading matching algorithm (TSOs: for efficient capacity allocation; NEMOs: for efficient matching).
- All NEMOs and all TSOs shall cooperate to finalise the set of the all-TSO and all-NEMO DA and ID Algorithm Requirements
- All NEMOs shall develop a proposal for the algorithm in accordance with these requirements. This shall be submitted to all TSOs to ensure that proposal complies with the requirements
- Agreed with NRAs that the consultation on all proposals - i.e., the all-TSO and all-NEMO DA and ID Algorithm Requirements and the all-NEMO proposal for the Algorithm Proposal - will be consulted upon together to ensure efficient assessment of their content by market participants
- The all-NEMO proposal for the Algorithm Proposal incorporating the all-TSO and all-NEMO DA and ID Algorithm Requirements and taking into account the comments from the consultation will be submitted to the regulatory authorities for approval no later than 18 months after the entry into force of the CACM Regulation - i.e., 14 February 2017
- All NEMOs and all TSOs shall review the operation of the DA and ID Algorithms every two years and submit report to ACER

Algorithm Proposal – Article 4 (DA Algorithm)

- The price coupling algorithm shall be based on the PCR Euphemia algorithm initially developed and operational in the MRC and 4MMC regions
 - Latest version Euphemia E10 to be launched 2017
- Key aspects of proposed DA algorithm
 - utilises quadratic linear programme plus heuristic rules that seek to maximise overall economic welfare
 - first aim is to find a solution that complies with the inputs and solution constraints; then seek to find solutions with higher economic welfare within the operational time allowed
 - orders shall be anonymous
 - a single instance of the price coupling algorithm operated by the coordinator shall calculate the results for all coupled NEMO Trading hubs
 - possible for other operators to perform the price coupling calculation in parallel
- NEMO Committee shall establish the operational procedures and timings, including both normal procedures and backup procedures, consistent with operational requirements under CACM. NEMOs shall be required to comply with these procedures

Context – MRC normal operational timing

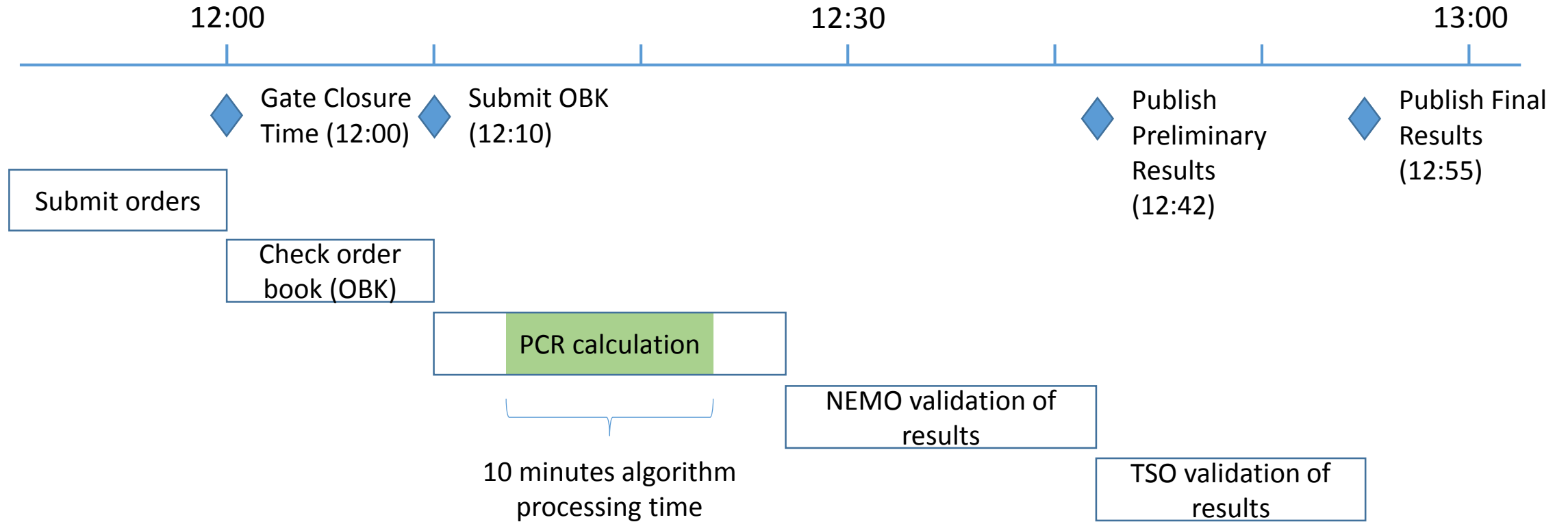

Algorithm Proposal – Article 5 (ID Algorithm)

- The continuous trading matching algorithm shall be based on the XBID solution initially developed in the NWE+ group of countries
- Key aspects of proposed ID algorithm:
 - comprises a shared order book (SOB) module and a capacity management module (CMM). The SOB module manages order entry, order management and order matching, while the capacity management module manages transmission capacity management and allocation
 - enables multiple NEMOs to connect to the central SOB module. Orders are entered in the local trading solutions; market participants are not entitled to access the shared order book directly
 - SOB matches all contracts (including from the same area). NEMOs are entitled to match other local contracts themselves outside
 - Explicit participants directly access the CMM to perform explicit capacity reservations
 - SOB module determines the local view of all orders that can be executed in the selected delivery area – i.e., local orders plus orders from connected delivery areas where there is available transmission capacity.
 - where a cross-zonal trade is identified in the SOB, a request to CMM to reserve the associated cross-zonal capacity. Requests to reserve capacity shall be queued along with explicit capacity requests and treated in time sequence. If the necessary cross-zonal capacity is not available, the trade is not matched.

Algorithm Proposal – Article 6 (management)

- Algorithm Performance shall be controlled and measured by the NEMO Committee against criteria to be set in consultation with the MESC
- NEMO Committee shall investigate and to the fullest extent possible share its findings with the MESC on any significant performance deterioration or non-compliance with an implemented Algorithm Requirement
- The NEMO Committee shall maintain a public description of the DA and ID Algorithm
- The NEMO Committee shall provide additional reasonable support for stakeholders to assist them in their understanding of the DA and ID Algorithm and issues related to it

Algorithm Proposal – Article 7 (changes)

- Implementation of new *Functionality, Activation* or changes to *Usage* are subject to Change Request (CR)
- Approval of Change Requests based on impact on objective, non-discriminatory criteria
 - Activation/usage changes may only induce a proportionate, controlled impact on the Algorithm Performance
 - Securing of the Algorithm Performance is key consideration to decide upon the acceptance of a Change Request
- All NEMOs and all TSOs equally able to request or use a Functionality if they pay for it; may not unreasonably block a request from individual parties to implement/use a particular Functionality

Algorithm Proposal – Article 7 (usage)

- NEMO Committee is entitled to set Usage Limits which limit the level of usage of a particular Functionality where necessary to ensure that Algorithm Performance shall be maintained at a satisfactory level
- Aim to meet following goals:
 - Respect for current use (“Effective Usage”)
 - Support geographic expansion
 - Support fair competition among NEMOs
 - Support development of fair and efficient competitive energy markets
- Consult with MESC for guidance if unable to meet these goals while maintaining Algorithm Performance at a satisfactory level

Algorithm Proposal – Article 7 (consultation)

- Change Requests categorized/managed as follows:
 1. *Non-Notifiable Change*: Stakeholders not informed of change – where not impacted
 2. *Notifiable Change*: Stakeholders informed of change (ahead of implementation) – where the change is non-discretionary but there is potential impact for market parties
 3. *Consulted Change*: NEMO Committee must consult Stakeholders and take response into consideration (agree form of the consultation with MESC) – where there is material potential adverse market impact and discretionary choices exist
- NEMO Committee determines approach; transparency towards MESC (who can request a change)
- Full Article 12 amendment process if necessary

Algorithm Proposal – Article 7 (decisions)

- Change Requests (including setting Usage Limits) must be approved by NEMO Committee, in coordination with TSOs where TSO Algorithm Requirements impacted
- NEMO Committee is entitled to decide to refer a decision in accordance with this Algorithm Proposal to an arbitral tribunal to be established by NEMOs for a binding decision
- Any NEMO or TSO is entitled to challenge a decision taken by the NEMO Committee in accordance with this Algorithm Proposal by requesting a referral to the arbitral tribunal

Algorithm Proposal – Points for Discussion

- Basing DA and ID algorithms on PCR and XBID
- Emphasis on monitoring and maintaining algorithm performance and what should be the critical parameters of algorithm performance (DA; ID)?
- Transparency regarding the algorithms (public description, performance and incident reporting, consultation on changes, reporting to MESC)
- Controls on usage and change requests for new functionality, to maintain DA and ID algorithm performance
- Managing changes according to nature of impact/discretionary choice
- Need/nature of a decision escalation body (“arbitral tribunal”); role of MESC, ACER/NRAs?

Agenda



10:30 – 10:45 Introduction

10:45 – 12:30 Max-Min Price Proposal;
Back-up Methodology Proposal

12:30 – 13:30 Lunch

13:30 – 16:30 Algorithm Proposal incorporating Day-Ahead and Intraday
algorithm requirements;

Products Proposal

16:30 – 17:00 Wrap-up

Products Proposal – Context (Article 40, 54)

- NEMOs shall submit a joint proposal concerning products that can be taken into account in the single day-ahead coupling/single intraday coupling
- NEMOs shall ensure that orders resulting from these products are expressed in euros and make reference to the market time
- All NEMOs shall ensure that the price coupling/continuous trading matching algorithm is able to accommodate orders resulting from these products covering one market time unit and multiple market time units
- By two years after the entry into force of this Regulation and every second subsequent year, all NEMOs shall consult in accordance with Article 12: (a) market participants to ensure that available products reflect their needs; (b) all TSOs, to ensure that the available products take into account operational security; (c) all regulatory authorities, to ensure that the available products comply with the objectives of this Regulation. NEMOs deem this consultation as being the first such consultation.
- Product Proposal will be submitted to the regulatory authorities for approval no later than 18 months after the entry into force of the CACM Regulation - i.e., 14 February 2017

Products Proposal – Key Aspects

- Proposal lists the ID and DA products to be supported from the initial go-live of the SDAC/SIDC
- Detailed product descriptions will be available in public documents (Euphemia description is an example)
- Products shall be made available to market participants in accordance with the relevant NEMO's market rules
- All orders resulting from these products submitted to the price coupling algorithm and continuous trading matching algorithm shall be expressed in euros and make reference to the market time. NEMOs are entitled to arrange that orders submitted by market participants are expressed and settled in local currencies or euros.
- NEMOs are entitled to introduce new or modified products subject to a change request. Such change request shall be subject to the Change Management Principles established in the Algorithm Proposal

Products Proposal – DA Products

- Aggregated Hourly Orders
- Complex Orders
 - MIC orders
 - Load Gradient orders
- Block Orders
 - Linked Block Orders
 - Exclusive Groups of Block Orders
 - Flexible Hourly Orders
- Merit Orders and PUN Orders

All these products shall be supported from the implementation of the SDAC

DA Algorithm requirements – classification 1

- State
 - Initial requirement: a requirement that must be complied with at the point the SDAC first commences operation. Such requirements are normally already incorporated into the PCR solution
 - Future requirement: a requirement that must be complied with at a point after the SDAC first commences operation. Such requirements shall need to be properly specified and implemented via a Change Request. Some Future Requirements may already be under development within PCR
- Owner
 - TSO
 - NEMO
 - Both

DA Algorithm requirements – classification 2

- Nature

- MCO Function: a requirement that relates to the joint responsibility of NEMOs to carry out MCO functions in accordance with Article 7(2).
- SEC (scheduled exchange calculation) function: requirement that relates to the joint responsibility of TSOs to calculate and publish scheduled exchanges on borders between bidding zones in accordance with Article 8(2)(g), where such requirement shall be supported by the DA Algorithm. In many cases these requirements are not yet specified (“Future”) and it may be that the calculations will be performed outside the DA Algorithm – e.g., as a separate post-matching process, or a local/regional process. The solution shall be agreed between the relevant NEMOs and TSOs.

DA Algorithm requirements: grouping

- Requirements on functionalities and performance
 - General requirements
 - Qualitative requirements with precision and price ranges
 - Performance
- Requirements related to cross-zonal capacities
- Requirement related to allocation constraints
- Requirements related to balance constraints
- Requirements on algorithm output and deadlines for the delivery of single day-ahead coupling results
- Currency

DA Algorithm requirements: Functionalities and performance

- The algorithm shall be able to:
 - Facilitate different MTUs, multiples NEMOs, multiples bidding zones and calculate one price and one net position per MTU/NEMO/Bidding zone.
- The objective of the price coupling algorithm is to maximize economic surplus for a SDAC consistent with time limitations.
- The algorithm shall always produce a unique results.
- NEMOs will publish statistical indicators that measure the performance
 - Optimality gap indicator(s)
 - Time performance indicators
 - Other that may be define (e.g. PRBs)

DA Algorithm requirements: Output and deadline

- Rounded and unrounded price for each bidding zone
- Rounded and unrounded net position for each bidding zone and NEMO hub.
- Number and volume of matched block orders for each bidding zone and paradoxically rejected order.
- Overall economic surplus and economic surplus for each bidding zone.

Optimality in DA (1)

- Optimality not feasible to guarantee in the 10 minutes given the complexity of the problem;
 - More than 50 bidding areas
 - Network constraints
 - Market demands (number of blocks, smart orders, PUN steps, etc). Non-convexities.
 - Heuristics are needed
- Maximising optimality is the goal
 - Supporting requirement; to find measures to indicate how close to optimality solution is. This can be a post process. Gap indicator is under study.

Optimality in DA (2)

- There are some tradeoff between quality of solution (welfare) and reproducibility;
 - Some heuristic techniques
 - Reinsertion of PRBs
 - Euphemia 9.3 (go-live 29 October 2015) first introduced the PRB reinsertion. Compared to E9.2 (no PRB reinsertion) on 2014 MRC data:
 - Welfare improved on average with 1700€;
 - Average number of PRBs (across MRC) decreased by 9.6 (~30% reduction)
 - Based on the MPs request to reduce PRBs, PCR focused on (significant) reduction of PRBs and increasing welfare. As a result the reproducibility was outweighed by the increase in quality
 - This information was communicated transparently to stakeholders, and will continue to do so in the next MESC.

Optimality in DA (3)

- **Proposed reproducibility**
 - New expected version of the algorithm (E10) which will apply parallel processes, making it very hard to replicate the calculation easily. Therefore reproducibility needs to be replaced by auditability.
 - By term auditability is indicated the ability of a session running to be duplicated in all or part of its phases, using some logged information from original run
 - Re-run the processing of a single job (e.g. finding a feasible solution)
 - In order to grant 100% reproducibility of a job, job description files should be written by Euphemia during the original run

Optimality in DA (4)

- An algorithmic solution (“Non Uniform Pricing”) offering likelihood of full optimality was identified by PCR and discussed with market parties last year
 - Allowed Paradoxically Accepted Blocks to be accepted, if increased welfare
 - Required extra payment to ensure PAB offer price was respected
 - Would result in different market buy and sell prices (surplus required to compensate PABs)
- Assessment
 - Significantly simplifies calculation – optimality is likely
 - More welfare than feasible with the current pricing rules
 - CACM imposes strict linear pricing (“*all accepted bids will have the same price per bidding zone*”, Art 38) – would require change to CACM
 - Market concern about reference prices, materiality of impact
- Conclusion
 - Remains an option, but currently there is not a sufficient case for change
 - Initiation for such a change could in future be triggered by the bi-annual product/algorithm review

Products rationalisation in DA (1)

- PCR project decided to take into account all products requested by market participants
 - The challenge was to develop an Algorithm able to manage all requirements and all products; the result was successful and minimized the impact on market participants.
 - Some products have evolved due to market requirements
 - The initial products are the current PCR products
- Functionality is working well
 - Products can be limited if they impact in the performance independently of heavily/not heavily used.
 - Impact depends on usage of Functionality, not the Functionality itself

Products rationalisation in DA (2)

- New products
 - The Product methodology proposes to review the products in two years.
 - PCR with the support of the Algorithm developer proposed a “Thermal Order” product to replace many of the (curtailable) block orders, exclusive groups, and complex orders.
 - Uncertain whether it would improve performance (depends on whether 1 thermal order replaces many block orders).
 - There was a limited interest from market parties.

Products rationalisation (3)

A new “Thermal order”

- Model a thermal unit
 - Minimum stable generation (similar to minimum acceptance ratio)
 - Load gradient (similar to complex orders)
 - Start up profile and cost (similar to MIC fixed term)
 - Minimum running time when started, minimum down time
 - Shut down profile (similar to scheduled stop)
 - Must run conditions (capacity not available to the market)
 - Flexible in time (similar to exclusive groups)
 - Variable cost per generated MWh (to consider fuel cost, similar to MIC variable cost)
- Could thus generalize (curtailable) block orders, exclusive groups, and complex orders.
- Would be much easier to specify for market participants

Products rationalisation (4)

Graphical definition

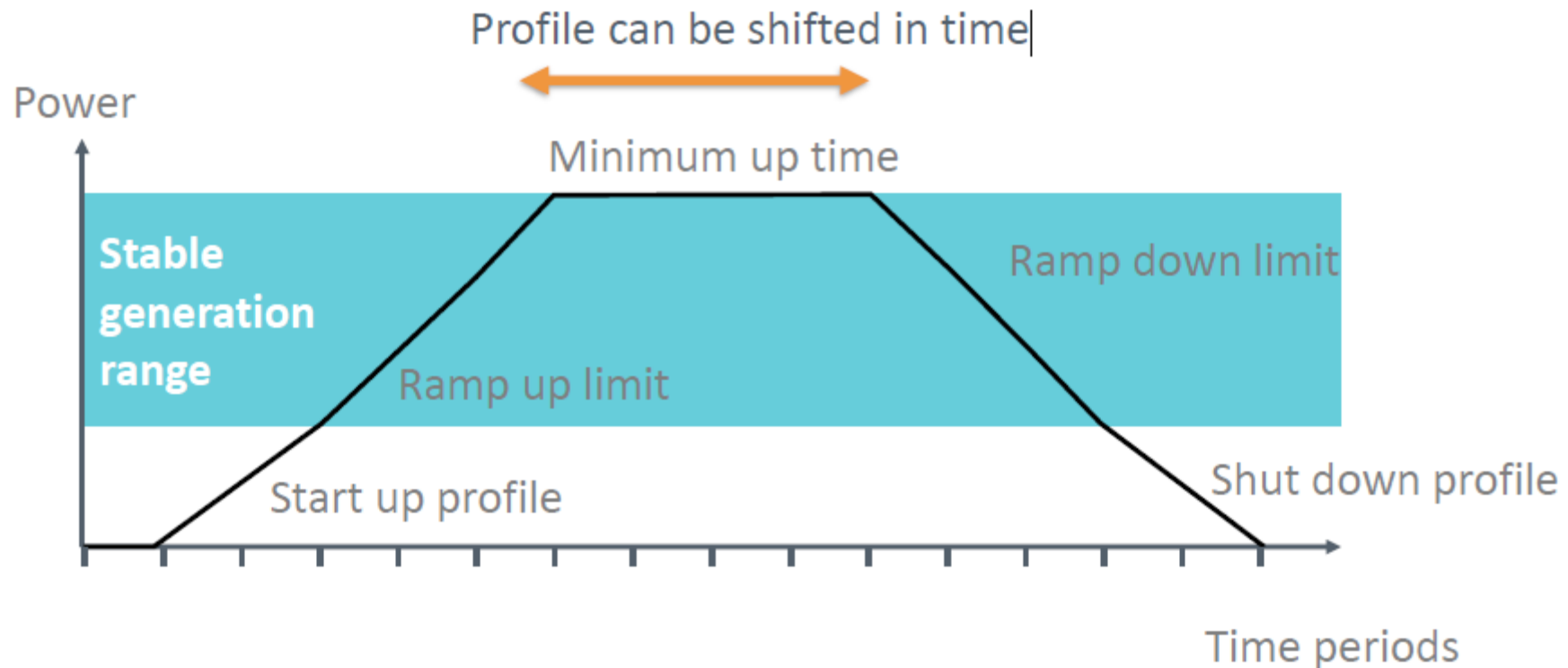

Non Uniform Pricing

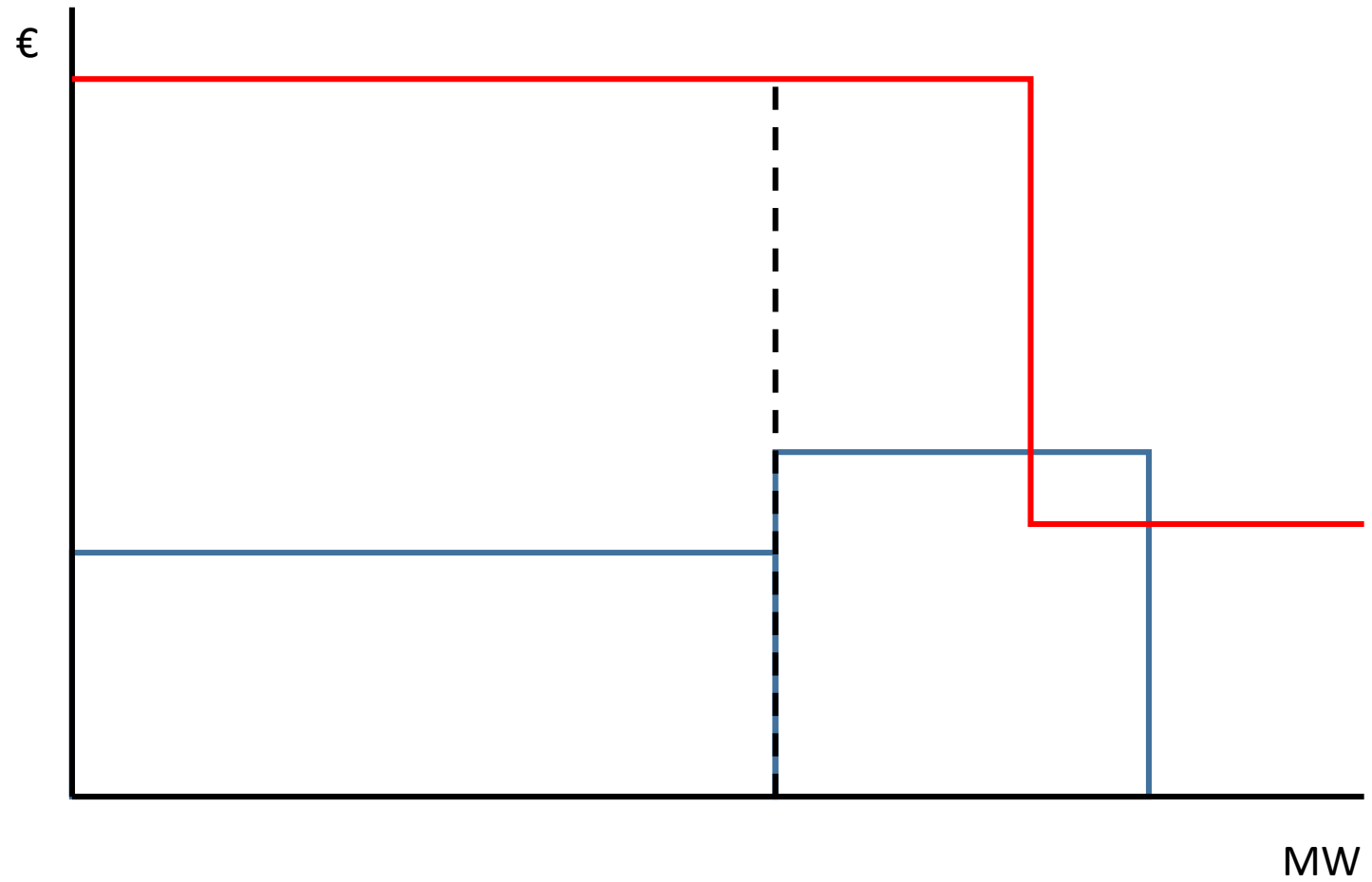

Non Uniform Pricing

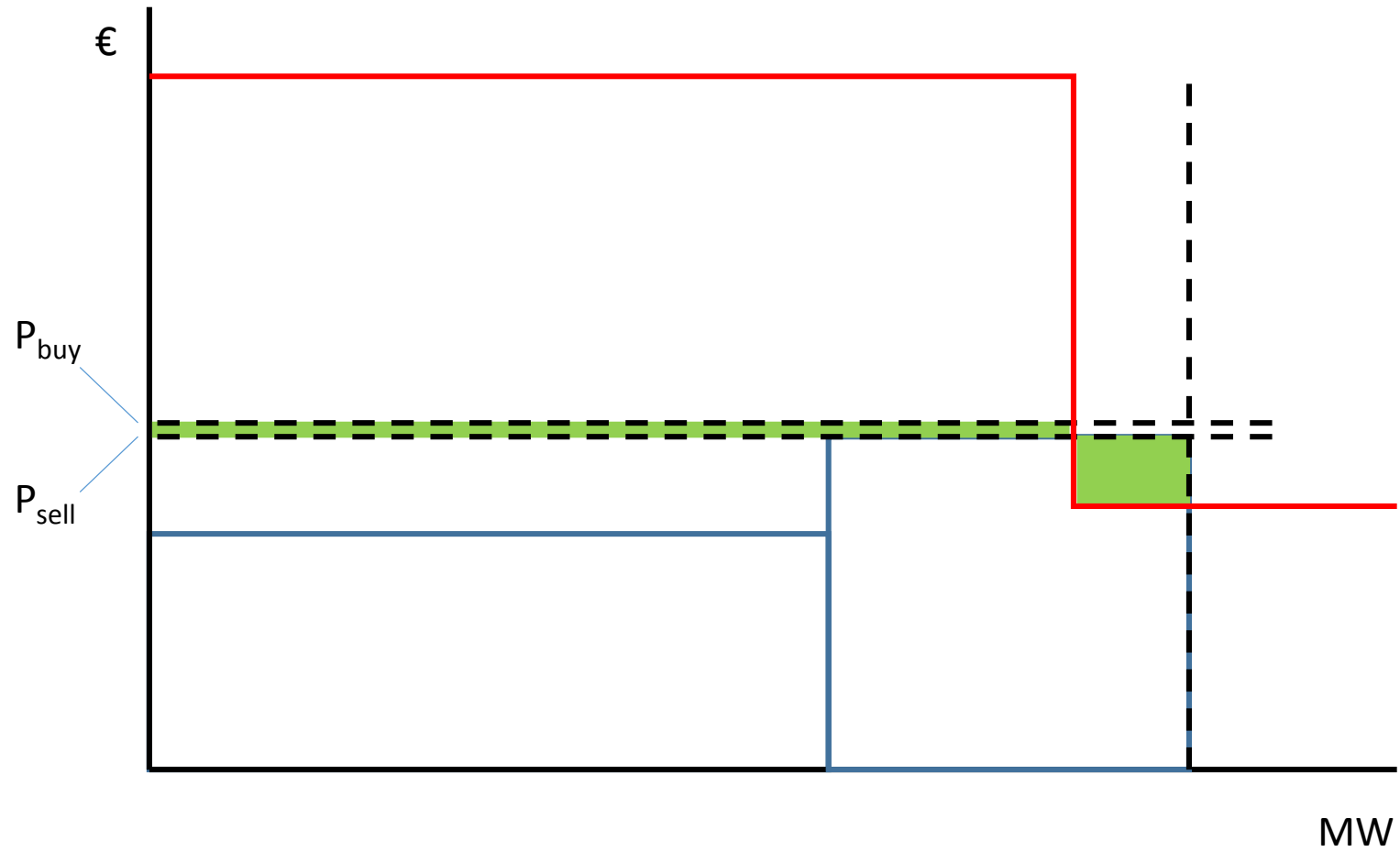

Products Proposal – ID Products

- ID Products supported from the implementation of the SIDC:
 - Hourly Orders
 - Half-hourly Orders
 - Quarter-hourly Orders
 - Block Orders being single-type aggregations of hourly, half-hourly or quarterly orders
 - Linked Orders
 - Iceberg Orders
- Non-standard products (as required under Article 65 to the extent that this is technically feasible and approved by the competent regulatory authorities) shall be implemented [within 6 months] following validation by the NEMO Committee of the detailed requirements and acceptance of any change request for Implementation of any required new or modified functionality, in accordance with the Algorithm Proposal

Block orders and linked orders

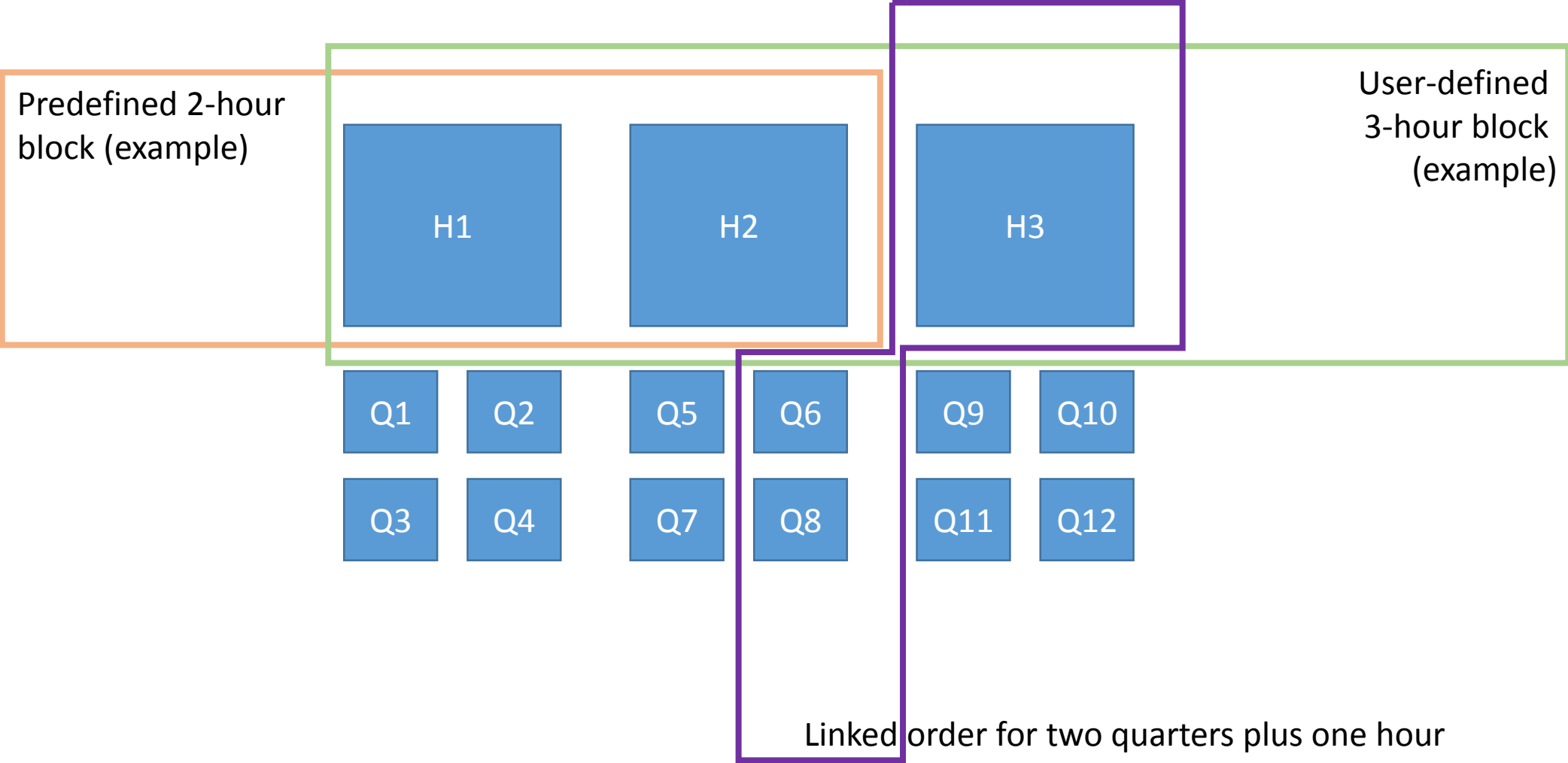

More linked orders

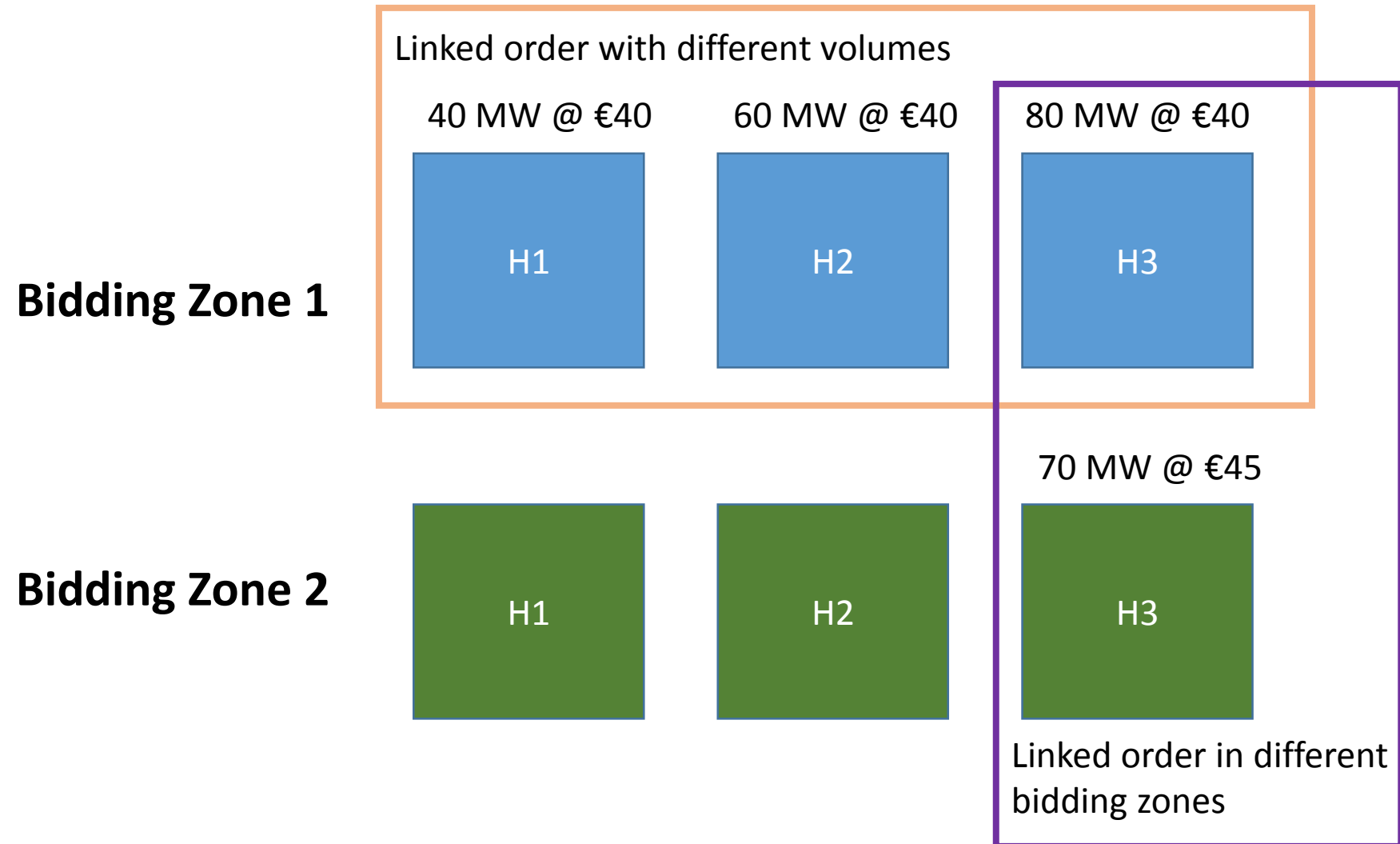

Iceberg orders

Upon entry in the market

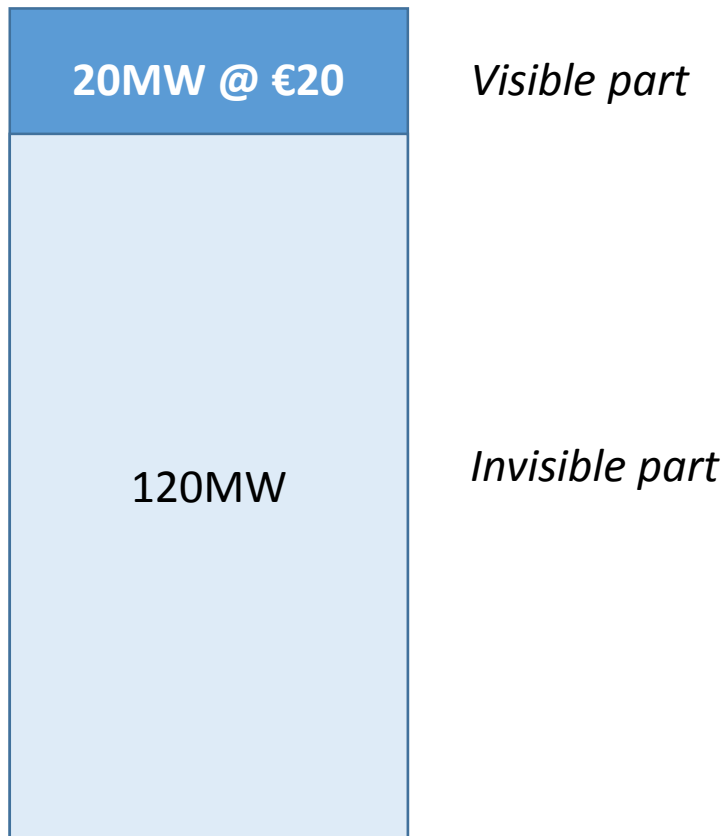

After matching of the first slice

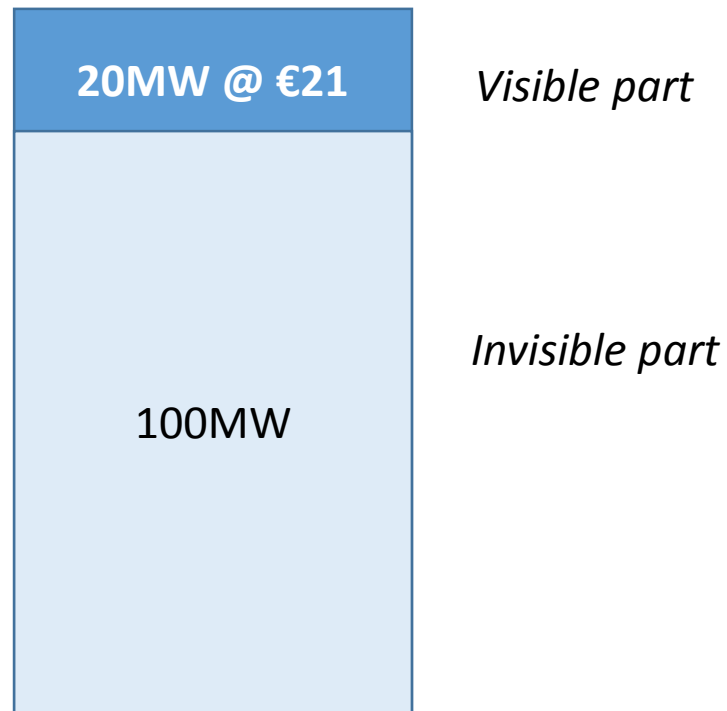

Total volume: 140 MW
Slice size: 20 MW
Original price: €20
Peak price delta: €1

Order execution restrictions

- None (NON) – The order is either executed immediately, or, if the order can't be matched right away, entered into the order book. Partial executions are allowed.
- Immediate-or-Cancel (IOC) – The order is either executed immediately, or, if the order can't be matched, deleted without entry in the order book. Partial executions are allowed.
- Fill-or-Kill (FOK) – The order is either executed immediately and with its full quantity or, if the order can't be matched with its entire quantity, deleted without entry in the order book.
- All or Nothing (AON) – The order is either executed against exactly one other order with its full quantity or entered into the order book. Partial executions are not allowed. Applicable only for user-defined contracts.

ID Algorithm requirements – classification 1

- State
 - Initial requirement: a requirement that must be complied with at the point the SIDC first commences operation. Such requirements are normally already incorporated into the XBID solution
 - Future requirement: a requirement that must be complied with at a point after the SIDC first commences operation. Such requirements shall need to be properly specified and implemented via a Change Request. Some Future Requirements may already be under development within XBID
- Owner
 - TSO
 - NEMO

ID Algorithm requirements – classification 2

- Nature

- MCO Function: a requirement that relates to the joint responsibility of NEMOs to carry out MCO functions in accordance with Article 7(2).
- SEC (scheduled exchange calculation) function: requirement that relates to the joint responsibility of TSOs to calculate and publish scheduled exchanges on borders between bidding zones in accordance with Article 8(2)(g), where such requirement shall be supported by the ID Algorithm (i.e., the SOB and/or CMM). In many cases these requirements are not yet specified (“Future”) and it may be that the calculations will be performed outside the ID Algorithm – e.g., as a separate post-matching process, or a local/regional process. The solution shall be agreed between the relevant NEMOs and TSOs.

ID Algorithm requirements: grouping

- General requirements
 - Overall requirements (mainly on matching)
 - Qualitative requirements with precision and price ranges
 - Other functionalities related to cross-zonal capacity allocation
 - Performance requirements
- Requirements related to cross-zonal capacities
- Requirement related to allocation constraints
- Requirements on algorithm output and deadlines for the delivery of single intraday coupling results
- Currency requirement(s)

General requirements

- Continuous matching of orders and allocation of capacity
- Support explicit capacity requests
- Support multiple NEMOs in one bidding zone
- Scalable to cover all Europe
- Produces (aggregated) cross-zonal flows per MTU
- Transparent, secure, non-discriminatory, anonymous
- Capacity comes at zero price for market participants; capacity pricing is a future requirement
- Performance requirements: see next slides

Performance measurement in ID

- In DA, performance is very much related to the quality (optimality) of the results. There is only one daily calculation, with a significant correlation between duration of the calculation and quality of the result
- In ID, every single match – of one buy order with one sell order – requires a calculation of its own. Round-trip time (from order entry to reception of the matching result) is an important performance measure. The percentage of matchable orders remaining unmatched is an additional measure, as queueing may result in orders remaining unmatched because they are intercepted by gate closure.

Order round-trip

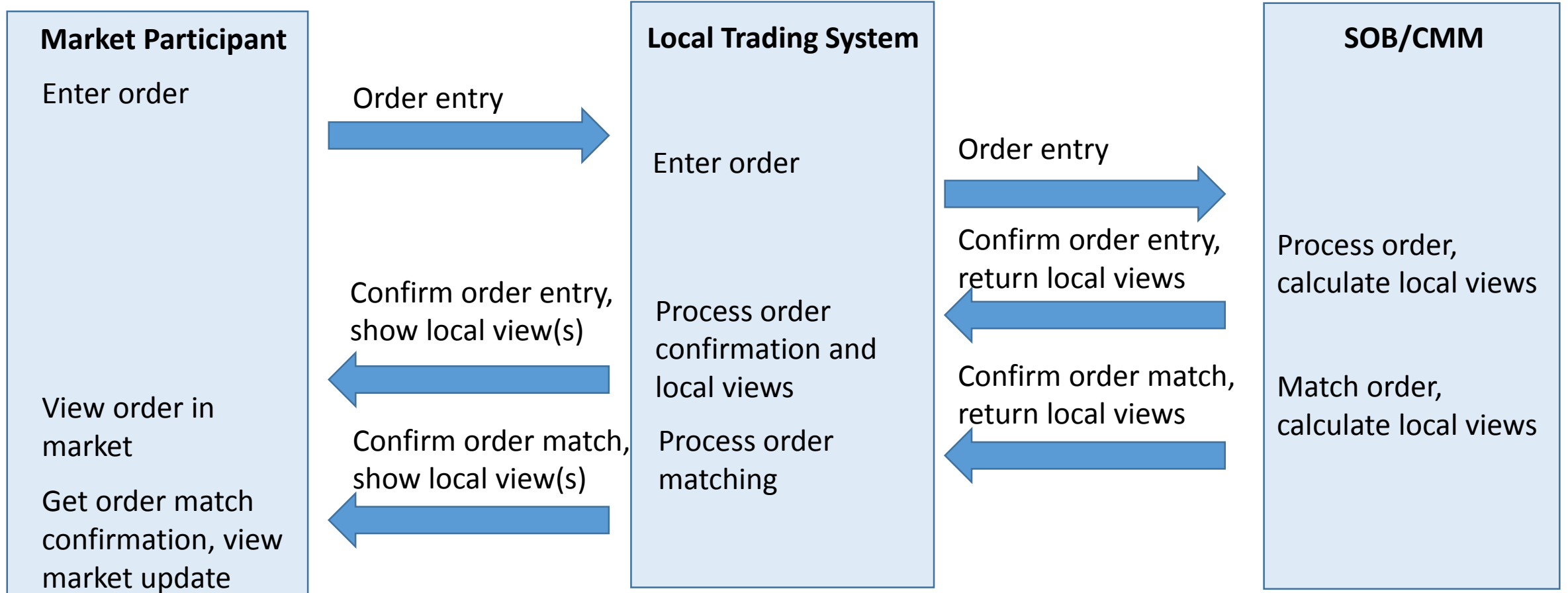

Gate closure may prevent order processing

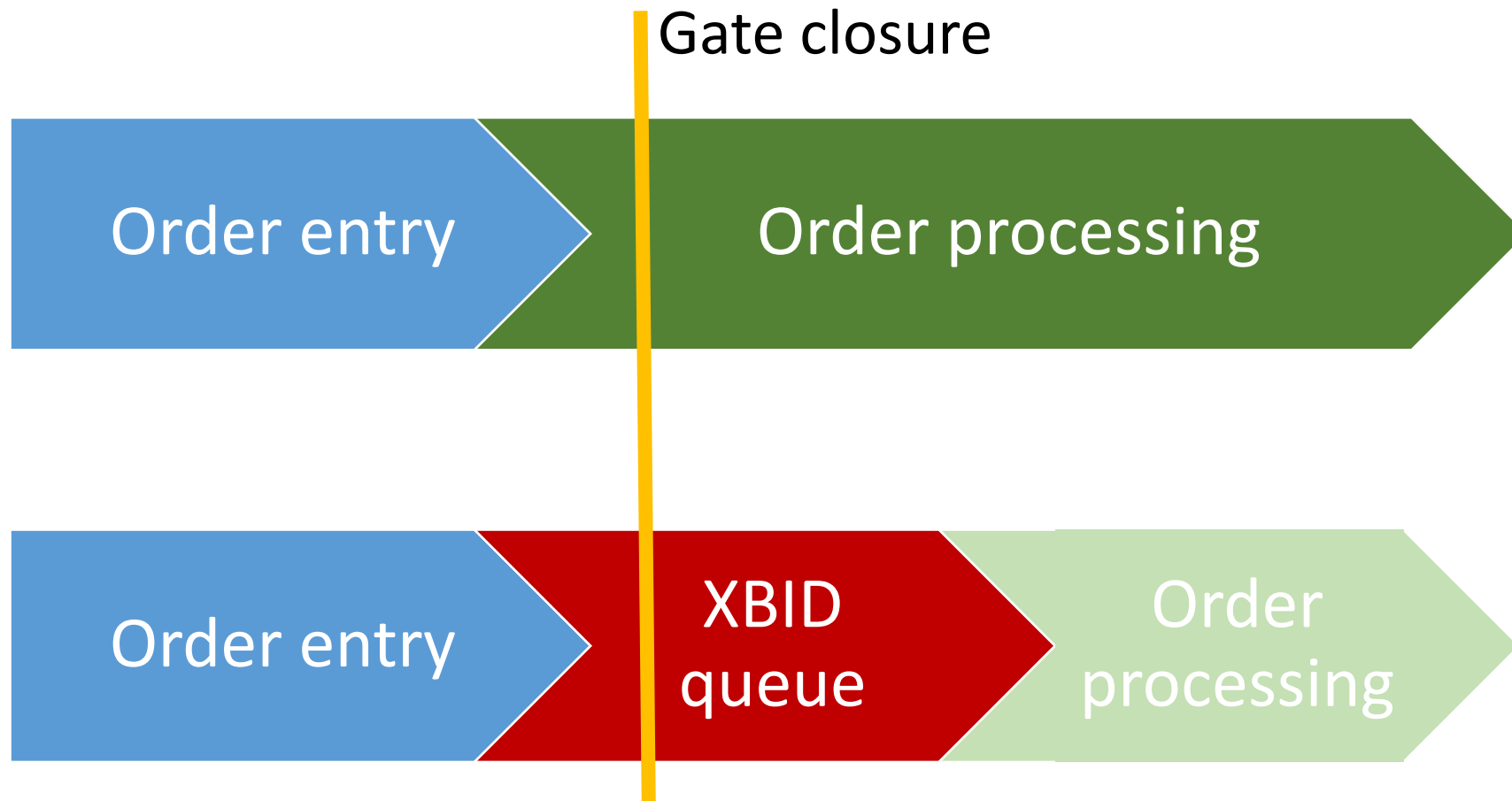

Requirements on cross-zonal capacities and allocation constraints

- Allow for cross-zonal capacity settings and ramping values
- Allow for flow-based capacity allocation (future)
- Halt and un-halt bidding zones, borders, instruments, NEMOs
- Allow for net position ramping (future)
- Take into account loss factors (future, underway)
- Minimum stable flow (future)
- Flow tariff (future)

Requirements on output and currency

- Output net positions per bidding zone
- Output scheduled exchanges between scheduling areas, bidding zones, NEMO trading hubs.
- Overall economic surplus (future)
- Output necessary for monitoring in accordance with Article 82(2) and (4) of CACM Regulation (future)
- REMIT-related output (future)
- Output must be delivered timely in view of post-processing
- Matching is in Euros only

Requirement on cross-matching

- One of the future requirements is about cross-matching
- This does not concern the matching of contracts across delivery areas; this is an initial requirement at the heart of the coupling of markets
- It does concern the matching of contracts belonging to different products against each other. Today, 60-minute orders can only be matched against other 60-minute orders. Cross-matching allows – for example – for one 60-minute order to be matched against four 15-minute orders.